



# PHILIPS SERVICE

# 208 U-01-19-40

 16,5-51 m (18,2-5,88 Mc/s)  9686 U-50 Z = 5 Ω  
 196-570 m (1530-522 kc/s)  110 V, 125 V, 220 V.  
 750-1910 m (400-157 kc/s)

452 kc/s ± 34 W

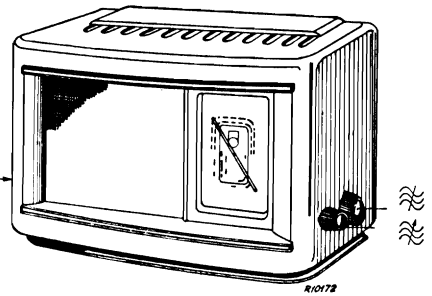

1943

	196-570 m	750-1910 m	16.5-51 m
VOL.	max	max	max
	C6, C8 + 15°	1875 m (160 kc/s)	17,8 Mc/s — Y
	1450 kc/s — Y	160 kc/s — Y	C6, C8 17,8 Mc/s
	C38 max	C50 max	C14 max
	C18 max		

15° 09 992 50.0

R11	0,45 + 0,05 M	49 500 23.0	C1	27 μF	49 021 03.0	
R31	0,82 MΩ	48 557 10/820K	C2	2,5 μF	49 021 04.1	
R32	10 KΩ	48 557 10/10K	C3	2,5 μF	49 021 04.1	
R33	68 KΩ	48 557 10/68K	C6	11-400 pF	A9 863 99.0	
R34	1,5 MΩ	48 557 10/1M5	C8	11-400 pF		
R35	6,8 MΩ	48 557 10/6M8	C14	32 pF	49 005 51.2	
R36	0,68 MΩ	48 557 10/680K	C18	32 pF	49 005 51.2	
R39	520 Ω	49 362 90,2	C19	39 pF	48 203 10/39E	
R40	600 Ω		C20	22 pF	48 201 10/22E	
R44	75 Ω		C38	32 pF	49 005 51.2	
R45	580 Ω		C40	33 pF	48 203 10/33E	
R42	5600 Ω		C48	395 pF	48 203 01/395E	
R43	150 Ω		48 494 10/150E	C50	200 pF	49 005 53.2
R46	4700 Ω		48 557 10/4K7	C51	103 pF	—
R75	220 Ω par		48 557 10/220E	C52	103 pF	—
	270Ω = 120Ω		48 557 10/270E	C61	103 pF	—
R81	47 KΩ		48 557 10/47K	C62	103 pF	—
R82	470 Ω	48 467 10/470E	C75	100 μF	48 313 22/100	
R100	10 KΩ	48 557 10/10K	C85	4700 pF	48 757 20/4K7	
			C100	1000 pF	48 757 20/1K	
			C101	100 pF	48 203 10/100E	
			C102	470 pF	48 203 10/470E	
			C103	82 pF	48 203 10/82E	
			C104	47000 pF	48 751 10/47K	
			C105	47000 pF	48 750 10/47K	
			C106	6800 pF	48 751 10/6K8	
			C107	100 pF	48 203 10/100E	
			C108	68 pF	48 203 10/68E	
			C110	22000 pF	48 758 20/22K	
			C111	56 pF	48 203 10/56E	
			C112	2,5 μF	49 021 04.1	
			C120	0,1 μF	48 751 10/100K	

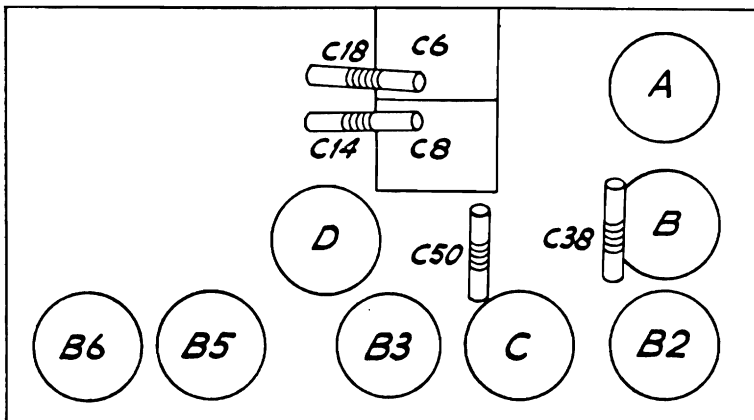

R14116

	B2	B3	B5	B6	
	UCH 21	UCH 21	UBL 21	UYIN	
Va	aT = 80 aH = 110	aT = 25 aH = 110	105	—	V
Vg2(4)	70	70	115	—	V
Vk	0	0	0	—	V
Ia	aT = 2,8 aH = 1,3	aT = 1,3 aH = 1,9	35	—	mA
Ig2(4)	2,6	1,3	5,6	—	mA

VC1 = 145 V, VC2 = 115 V, VC3 = 120 V, VC75 = 6 V, VS71 = 30 V, IS71 = 54 mA.

Copyright  
N.V. Philips Gloeilampenfabrieken, Eindhoven  
Imprimé en Hollande

S13, S14, S17, S18	A1 037 48.0*	S61, S62, S63, S64 C61, C62	{ A1 037 12.4*
S19, S20	A1 002 07.1	S 71	
S33, S34, S37, S38, S100	{ A1 038 83.1*	S76	49 981 13.1
S39, S40		A1 002 08.0*	S81, S82
S51, S52, S53, S54 C51, C52	{ A1 037 13.0*		

93953.11.1

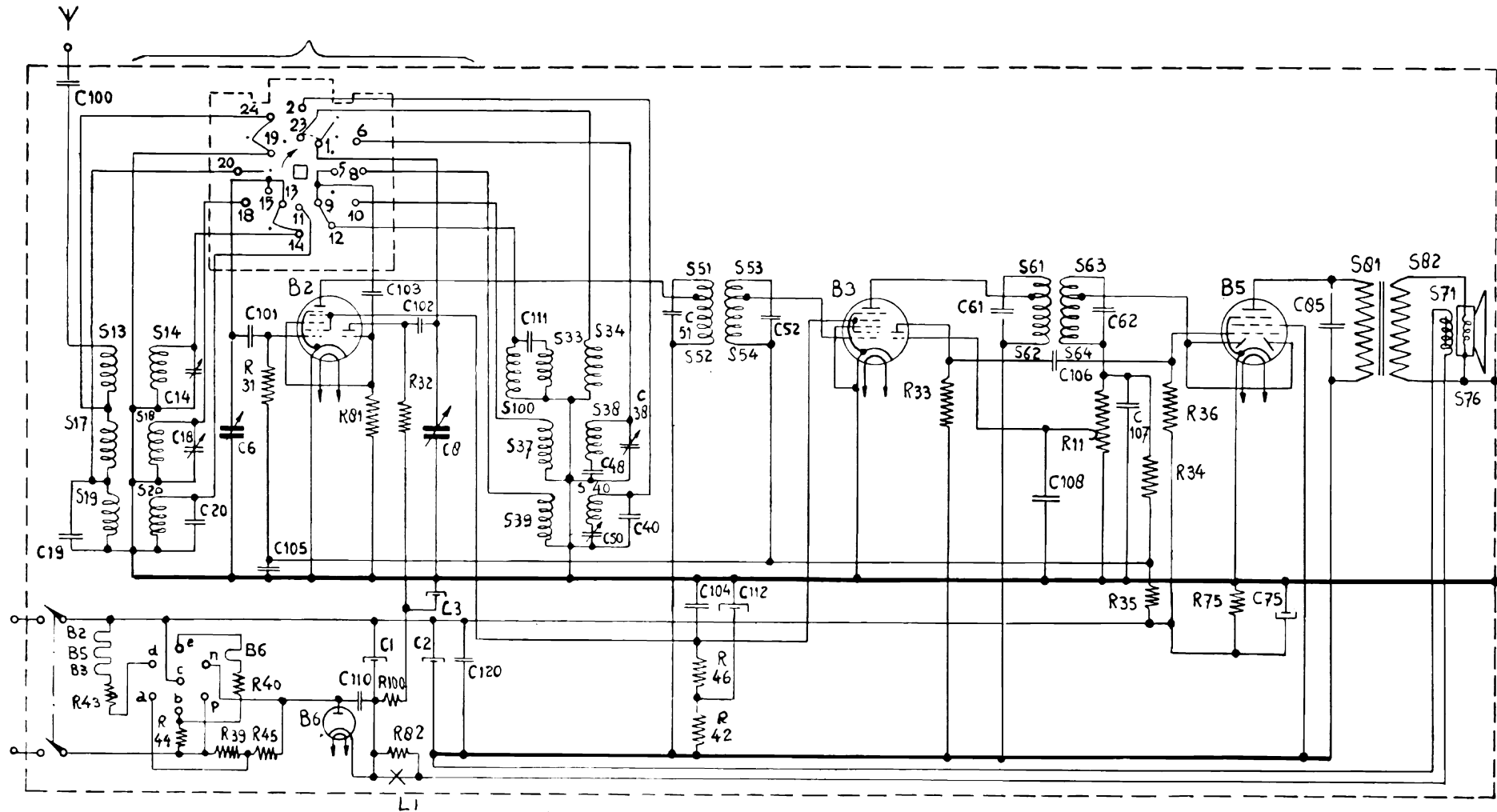

UCH 21

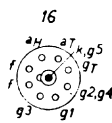

B 2

UCH 21

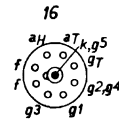

B 3

UBL 21

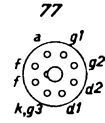

B 5

UYIN

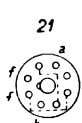

B 6

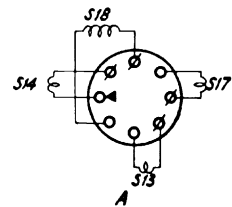

A

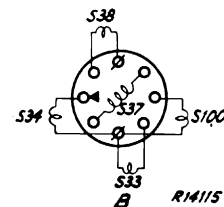

B

R1115

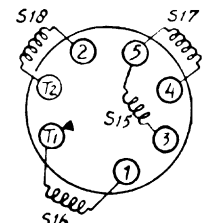

C

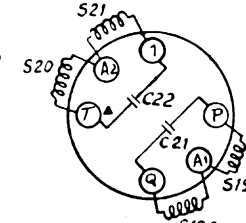

D

R10153