

13,5—45 m
45—160 m
160—570 m
700—2000 m
452 kc/s

9614 Z = 2.5 Ω

110—245 V

67 W

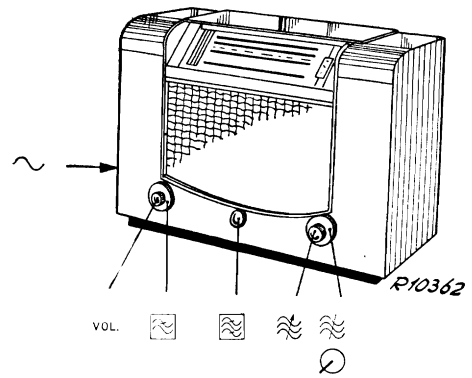

<p>160—570 m I</p> <p>C3, C4, C5 min. VOL. max. C5 452 kc/s-33000 pF-g4B2 S34/S35, S33/S41, S32, S31/S39 max. C5</p>	<p>700—2000 m III</p> <p>C3, C4, C5 + 15° VOL. max. 385 kc/s—Y C14, C11, C9 max. : C5 25 pF—aB2 150 kc/s—Y C3, C4, C5 max.</p>	<p>45—160 m III</p> <p>C3, C4, C5 + 15° VOL. max. 6,17 Mc/s—Y C12, C54, C7 max.</p>
<p>160—570 m II</p> <p>452 kc/s—Y C3, C4, C5 max. VOL. max. S6 min.</p>	<p>160—570 m III</p> <p>C3, C4, C5 + 15° VOL. max. 1725 kc/s—Y C13, C55, C8 max. : C5 25 pF—aB2 600 kc/s—Y C3, C4, C5 max. C5 C15 max.</p>	<p>13.5—45 m III</p> <p>C3, C4, C5 + 15° VOL. max. 20,5 Mc/s—Y C56, C10, C6 max.</p>

15° 09 992 44.0

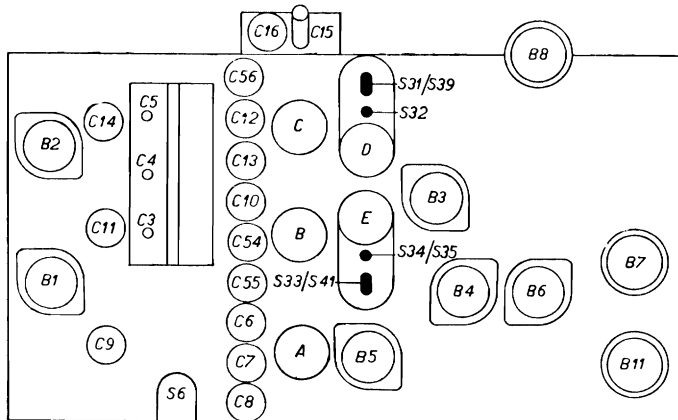

R10872

	B1	B2	B3	B4	B5	B6	B7	B8	B11	
	EF 8	EK 2	EF 9	EAB 1	EF 6	EL 3	AZ 1	EM 3	4496	
Va	245	210	250		<25	235	—	—	110	V
Vg2	—	110	90		<50	250	—	250	—	V
Vg3(5)	220	<50	—		—	—	—	—	—	V
Ia	5,8	1,2	6,1		4,9	43	—	0,8	—	mA
Ig2	—	2,3	1,7		0,17	6,3	—	0,17	—	mA
Ig3(5)	0,15	1.—	—		—	—	—	—	—	mA

VC1 = 270 V
VC2 = 250 V

Copyright - N.V. Philips
Gloeilampenfabrieken Eindhoven, Holland
Imprimé en Hollande

R1	47 Ω	48 426 10/47E	C1	32 μF	28 182 40.0
R2	0,1 MΩ	48 426 10/100K	C2	32 μF	28 182 40.0
R3	0,82 MΩ	48 426 10/820K	C3	11-490 pF	28 212 45.3
R4	15 Ω	48 425 10/15E	C4	11-490 pF	28 212 45.3
R5	47 Ω	48 425 10/47E	C5	11-490 pF	28 212 45.3
R6	470 Ω	48 426 10/470E	C6, C8	0-30 pF	28 212 36.3
R7	120 Ω	48 426 10/120E	C9	0-30 pF	28 212 45.3
R8	390 Ω	48 426 10/390E	C10	0-30 pF	28 212 36.3
R9	39 Ω	48 426 10/39E	C11	0-30 pF	28 212 45.3
R10	22000 Ω	48 425 10/22K	C12	0-30 pF	28 212 36.3
R13	68000 Ω	48 426 10/68K	C13	0-30 pF	28 212 36.3
R14	12500 Ω	28 802 74.0	C14	0-30 pF	28 212 45.3
R15	27000 Ω	48 426 10/27K	C15	200 pF	28 212 08.2
R17	82000 Ω	48 426 10/82K	C16	0-30 pF	28 212 45.3
R18	2,2 MΩ	48 427 10/2M2	C17	170 pF	48 429 02/170E
R19	4,7 MΩ	48 427 10/4M7	C18	47 pF	48 406 10/47E
R20	33 Ω	48 426 10/33E	C19	47 pF	48 406 10/47E
R21	47000 Ω	48 426 10/47K	C20	2 pF	28 205 88.0
R22	0,28 MΩ	49 470 56.0	C21	2 × 2 pF	28 205 88.0
R44	0,07 MΩ	48 427 10/70K	C22	22000 pF	48 756 20/22K
R23	1,5 MΩ	48 427 10/1M5	C23	100 pF	48 406 10/100E
R24	0,27 MΩ	48 426 10/270K	C24	0,39 pF	48 751 10/390K
R25	0,3 Ω	28 803 56.1	C25	47000 pF	48 751 10/47K
R26	0,39 MΩ	48 426 10/390K	C26	220 pF	48 406 10/220E
R27	0,22 MΩ	48 425 10/220K	C27	47000 pF	48 751 10/47K
R28	2 × 0,3 MΩ	49 472 53.0	C28	47000 pF	48 751 10/47K
R29	1000 Ω	48 425 10/1K	C29	10000 pF	48 751 10/10K
R30	0,47 MΩ	48 426 10/470K	C30	47000 pF	48 751 10/47K
R31	2700 Ω	48 426 10/2K7	C31	100 pF	48 406 10/100E
R32	39 Ω	48 426 10/39E	C32	1750 pF	48 429 02/1K75
R33	0,15 MΩ	48 426 10/150K	C33	5100 pF	48 429 02/5K1
R36	47 Ω	48 425 10/47E	C34	400 pF	48 429 02/400E
R37	10 Ω	48 425 10/10E	C35	150 pF	48 429 02/150E
R38	10 Ω	48 425 10/10E	C37	15000 pF	48 751 10/15K
R39	27 Ω	48 425 10/27E	C38	47000 pF	48 751 10/47K
R40	0,27 MΩ	48 426 10/270K	C39	47000 pF	48 751 10/47K
R41	4 Ω	28 803 64.1	C40	0,22 μF	48 751 10/220K
R42	56 Ω	48 426 10/56E	C41	94 pF	—
R43	22000 Ω	48 426 10/22K	C42	113 pF	—
			C43	113 pF	—
			C44	113 pF	—
			C45	100 pF	48 406 10/100E
			C46	10000 pF	48 751 10/10K
			C47	640 pF	48 429 10/640E
			C48	0,1 μF	48 751 10/100K
			C49	320 pF	48 429 10/320E
			C50	640 pF	48 429 10/640E
			C51	2200 pF	48 751 10/2K2
			C52	8,2 pF	48 406 99 8E2
			C53	2200 pF	48 751 10/2K2
			C54/	0-30 pF	28 212 36.3
			C56	39 pF	48 406 10/39E
			C57	1000 pF	48 429 10/1K
			C62	220 pF	48 406 10/220E
			C65	47000 pF	48 751 10/47K
			C66	0,1 μF	48 751 10/100K
			C67	12000 pF	48 751 10/12K
			C68	8,2 pF	48 406 99 8E2
			C69	8200 pF	48 751 10/8K2

S1, S2, S3, S4	28 537 01.0	S31, S32, S39,	28 573 59.1
S5	28 546 85.0	C41, C42	
S6	28 587 95.0	S33, S34, S35, S41	28 573 51.0
S7, S8, S9, S10	28 573 10.4	C43, C44	
S11, S12, S13, S14	28 573 12.4	S36, S37	28 537 39.2
S15, S16, S17, S18	28 573 11.3	S40	28 220 43.1
S19, S20, S21, S22		S42	28 546 93.0
S23, S24, S25, S26			
S27, S28, S29, S30			

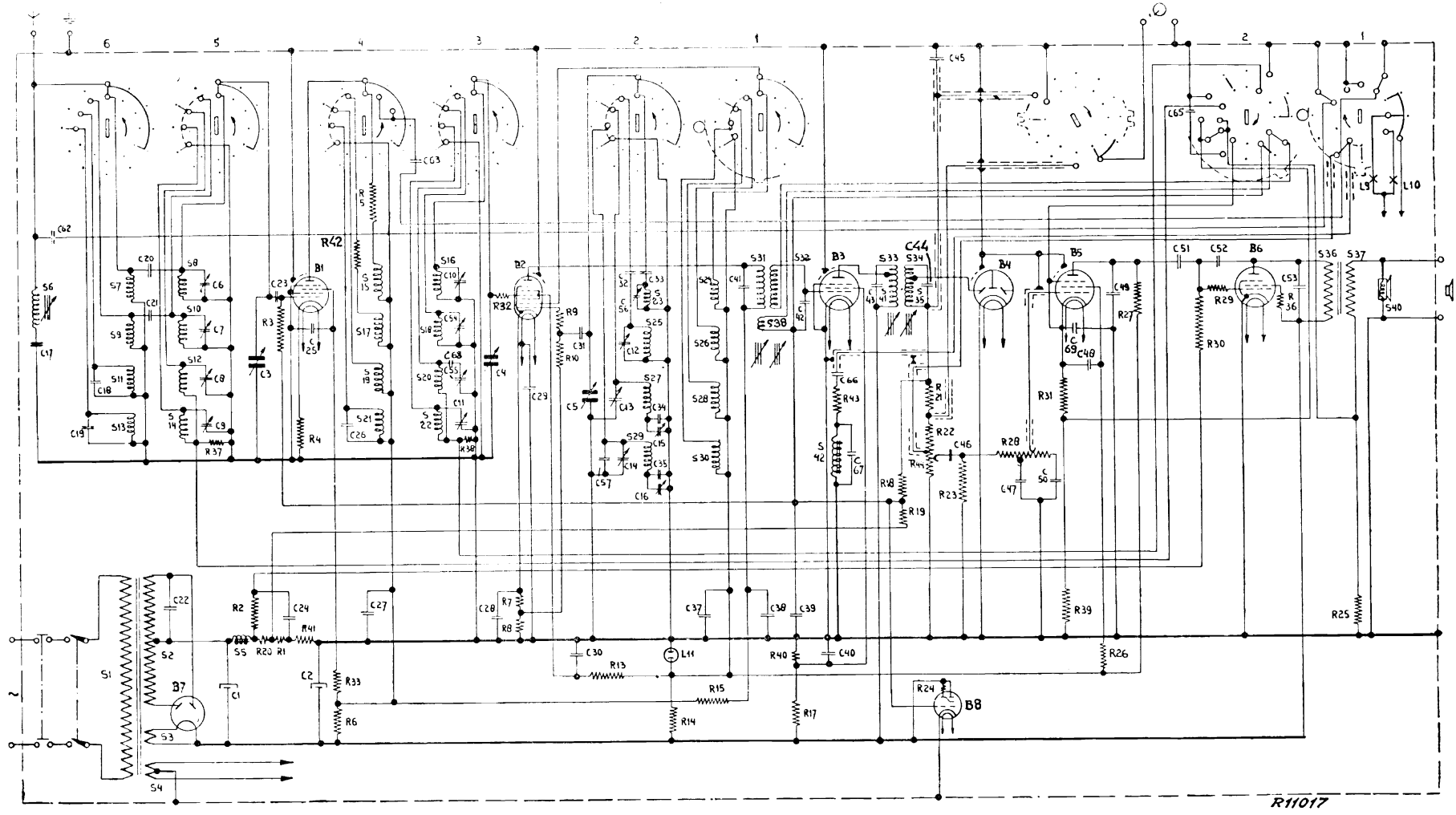

R11017

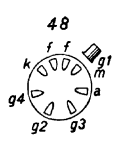

B1

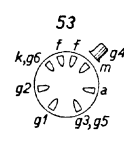

B2

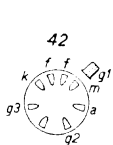

B3, B5

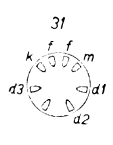

B4

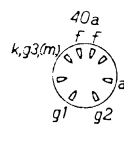

B6

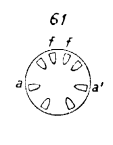

B7

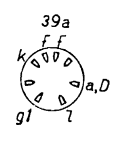

B8

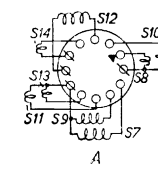

A

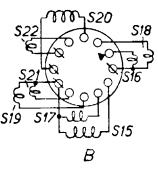

B

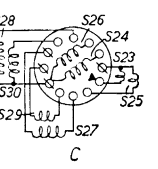

C

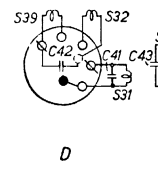

D

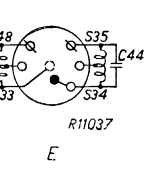

E

R11037