

13,7—51 m  
48—175 m  
175—585 m  
708—2000 m

468 kc/s  
A-07,-19,-32 452 kc/s

A-04,-06,-07 9636-05 Z = 5 Ω  
9636-55 (57) Z = 5 Ω

110-245 V

48 W  
A-04,-06,-07 58 W

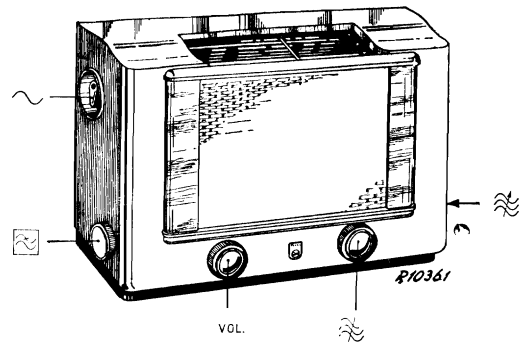

175—585 m III		708—2000 m III		175—585 m V	
VOL. max.		VOL. max.		115,4 kc/s—Y	
max.		max.		C6, C7 max.	
C6, C7 + 15°		25 pF—aB2		↑	260 m
1650 kc/s—Y		C7			
C18		160 kc/s—Y			
25 pF—aB2		C6, C7 160 kc/s			
C7		C7			
600 kc/s—Y		C7			
C6, C7 500 m		C49 max.			
C7					
C38 max.					

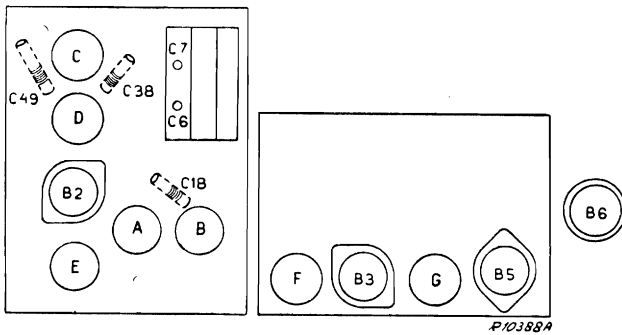

	B2	B3	B5	B6	B7	
	ECH 21	ECH 21	EBL 21	AZ 1	EM 4 <sup>2</sup> )	
V <sub>a</sub>	aT 60 aH 240	aT 60 aH 240	250			V
V <sub>g2</sub>	100	95	240			V
I <sub>a</sub>	aT 2,75 aH 2,70	aT 1,75 aH 4,9	31			mA
I <sub>g2</sub>	5,9	2,9	3,5			mA

V<sub>e1</sub> = 285 V  
V<sub>e2</sub> = 250 V

<sup>2</sup>) 768 A-19, A-07

R1	1200 Ω	48 467 10/1K2	C1	45 μF	49 032 01.0
R2	82 Ω	48 426 10/82E	C2	32 μF	28 182 40.0
R3	39 Ω	48 425 10/39E	C1	50 μF	49 031 10.2
R11	0,5 MΩ	49 470 30.0	C2	30 μF	49 020 01.0
R21	50000 Ω	49 470 49.0	C3	50 μF	49 020 01.0
R31	0,47 MΩ	48 425 10/470K	C6	11-490 pF	28 212 52.0
R32	39000 Ω	48 427 10/39K	C7	11-490 pF	28 212 52.0
R33	39000 Ω	48 427 10/39K	C14	5,6 pF	48 406 99/5E6
R34	68000 Ω	48 426 10/68K	C18	32 pF	28 212 06.2
R35	39 Ω	48 425 10/39E	C19	33 pF	48 406 10/33E
R41	47000 Ω	48 427 10/47K	C20	18 pF	48 406 10/18E
R42	0,1 MΩ	48 427 10/100K	C38	32 pF	28 212 06.2
R43	47000 Ω	48 425 10/47K	C40	39 pF	48 406 99/39E
R45	0,68 MΩ	48 425 10/680K	C45	637 pF	48 406 02/637E
R46	1,5 MΩ	48 426 10/1M5	C40	663 pF	48 406 02/663E
R47	0,82 MΩ	48 425 10/820K	C47	450 pF	48 406 01/450E
R48	0,82 MΩ	48 425 10/820K	C49	200 pF	28 212 08.1
R50	1,5 MΩ	48 426 10/1M5	C51	103 pF	—
R51 <sup>1)</sup>	22000 Ω	48 425 10/22K	C52	103 pF	—
R60	100 Ω	48 425 10/100E	C61	103 pF	—
R61	8200/2 Ω	48 468 10/8K2	C62	103 pF	—
R61 <sup>1)</sup>	4700 Ω	48 469 10/4K7	C81	22 pF	48 406 10/22E
R62 <sup>1)</sup>	5600 Ω	48 469 10/5K6	C82	82 pF	48 406 10/82E
R81	47000 Ω	48 425 10/47K	C83	22000 pF	48 750 20/22K
R85 <sup>1)</sup>	2700 Ω	48 467 10/2K7	C85	4700 pF	48 757 20/4K7
			C100	100 pF	48 406 10/100E
			C101	47000 pF	48 751 20/47K
			C102	470 pF	48 406 20/470E
			C103	82 pF	48 406 10/82E
			C104	47 pF	48 406 10/47E
			C120	47000 pF	48 751 20/47K
			C121	47000 pF	48 750 20/47K
			C122	10000 pF	48 751 20/10K
			C126	2200 pF	48 751 20/2K2
			C127	47000 pF	48 750 20/47K
			C128 <sup>1)</sup>	0,1 μF	48 751 20/100K
			C130	47000 pF	48 757 20/47K
			C131	22000 pF	48 756 20/22K

S1, S2, S3, S4	A1 070 04.4 A1 057 12.0 <sup>1)</sup> A1 037 14.0	S53, S54, S55, C52 S61, S62, S63, S64 C61, C62	A1 037 34.1
S13, S14, S15, S16 S17, S18, S19, S20 S33, S34, S35, S36 S37, S38, S39, S40 S51, S52, C51	A1 037 16.1 A1 037 32.0 A1 037 17.2 A1 037 33.1	S76 S77 <sup>1)</sup> S81, S82	A1 037 61.1 28 220 51.1 A1 001 62.1 A1 081 84.1

<sup>1)</sup> 768A-04  
A-06  
A-07

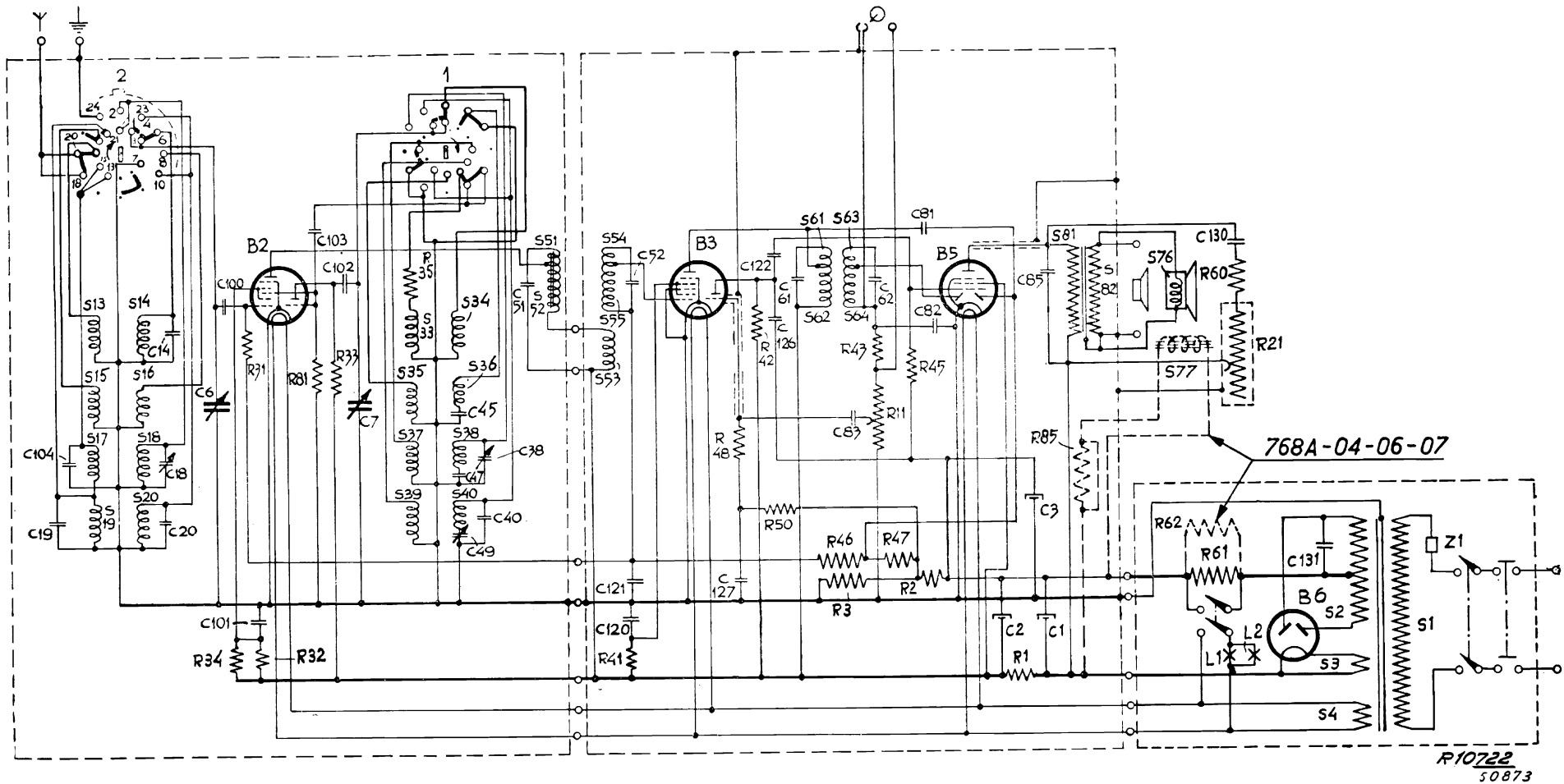

768A-04-06-07

R10722  
50873

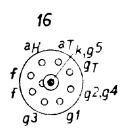

B2, B3

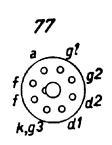

B5

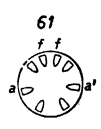

B6

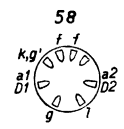

B7

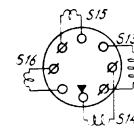

A

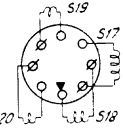

B

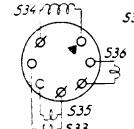

C

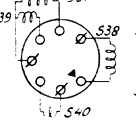

D

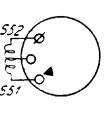

E

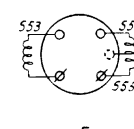

F

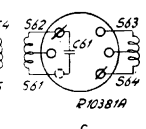

G

768 A