





# PHILIPS-SERVICE

# 796 U

 16,5—51 m  
 198—585 m  
 725—2000 m  
 U-32 128 kc/s  
 125 kc/s





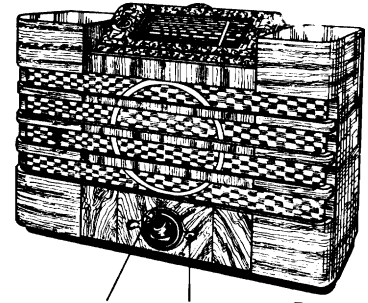

 9604 Z = 5 Ω

 110 V, 125 V, 145 V,  
 200 V, 220 V, 245 V

55 W



 VOL  
 

 725—2000 m I	 725—2000 m II	 725—2000 m III
C10, C11, C12 min VOL max  128 kc/s—33000 pF-g4B <sub>1</sub> 125 kc/s (U-32) C24—25000 Ω C25 max C24 C23—10000 Ω—0,1 μF C22 max C23 C25—25000 Ω C24 max C25 C22—10 000 Ω—0,1 μF C23 max C22	C10, C11, C12 max VOL max  128 kc/s—Y 125 kc/s (U-32) C13 min 198—585 m III VOL max  C10, C11, C12 + 15° 1442 kc/s—Y C17, C14, C15 max. 550 kc/s—Y 25 pF—aB1 C22—2000 Ω—0,1 μF C10, C11, C12 550 kc/s C22 C20 max	VOL max  C10, C11, C12 + 15° 395 kc/s—Y C18 max 160 kc/s—Y 25 pF—aB1 C22—2000 Ω—0,1 μF C10, C11, C12 160 kc/s C22 C19 max 16,5—51 m III 17 Mc/s—Y VOL max C10, C11, C12 + 15° C16 max 198—585 m IV 744 kc/s—Y VOL max C10, C11, C12 744 kc/s 1000 kc/s—Y C46 min

15° 09 992 44.0

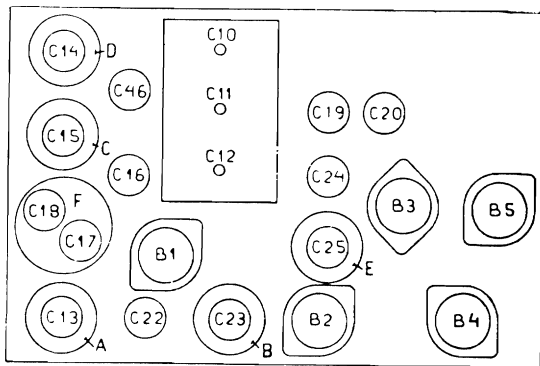

R10474A

	B1	B2	B3	B4	B5	B8	
	AK2	AF3	ABC1	AL4	AZ1	AM1	
Va	280	250	105	267			V
Vg2(3,5)	80	80	—	280			V
-Vg	2	9	6,3	7,2			V
Ia	1,9	5,5	1,1	39			mA
Ig2	1,6	1,7	—	4,1			mA
Ig3(5)	4	—	—	—			mA

Vc1 = 290 V  
Vc2 = 275 V

1) 796U-20, —29

R1	82000/3 Ω	48 427 10/82K	C1	25 μF	48 312 09/25
R3	47000 Ω	48 425 10/47K	C2	25 μF	48 312 09/25
R4	270 Ω	48 425 10/270E	C3	50 μF	48 313 02/50
R5	820 Ω	48 425 10/820E	C4	50 μF	48 313 02/50
R6	33 Ω	48 425 10/33E	C5	0,1 μF	48 751 10/100K
R7	3300 Ω	48 425 10/3K3	C6	0,1 μF	48 751 10/100K
R8	3900 Ω	48 425 10/3K9	C7	0,47 μF	48 751 10/470K
R9	150 Ω	48 426 10/150E	C8	47000 pF	48 751 10/47K
R10	0,1 MΩ	48 425 10/100K	C9	0,1 μF	48 751 10/100K
R11	47000 Ω	48 425 10/47K	C10	11-470 pF	28 211 42.1
R12	1 MΩ	48 426 10/1M	C11	11-470 pF	—
R13	0,47 MΩ	48 425 10/470K	C12	11-470 pF	—
R14	0,1 MΩ	48 425 10/100K	C13	12-270 pF	—
R15	0,5 MΩ	28 810 972	C14	2,5-30 pF	—
R16	1,5 MΩ	48 426 10/1M5	C15	2,5-30 pF	—
R17	1,5 MΩ	48 426 10/1M5	C16	2,5-30 pF	28 211 83.1
R18	0,1 MΩ	48 426 10/100K	C17	2,5-30 pF	28 211 83.1
R19	0,82 MΩ	48 425 10/820K	C18	2,5-30 pF	—
R20	0,1 MΩ	48 425 10/100K	C19	12-170 pF	28 211 31.0*
R21	220 Ω	48 425 10/220E	C20	12-170 pF	28 211 31.0*
R22	5 MΩ	28 811 431	C22	12-170 pF	28 211 31.0*
R24	1,5 MΩ	48 426 10/1M5	C23	12-170 pF	—
R25	1000 Ω	48 425 10/1K	C24	12-170 pF	28 211 31.0*
R26	33 Ω	48 425 10/33E	C25	12-170 pF	—
R27	33 Ω	48 425 10/33E	C26	500 pF	48 429 10/500E
R28	1000 Ω	48 426 10/1K	C27	47000 pF	48 751 10/47K
R31	2700 Ω	48 425 10/2K7	C28	10 pF	48 406 99/10E
R32	47 Ω	48 425 10/47E	C29	15000 pF	48 751 10/15K
R33	2700 Ω	48 425 10/2K7	C30	27000 pF	48 751 10/27K
R34	1,5 MΩ	48 426 10/1M5	C31	15 pF	48 406 10/15E
R35	4,7 MΩ	48 427 10/4M7	C32	650 pF	48 429 02/650E
R36	2,2 MΩ	48 427 10/2M2	C33	1375 pF	4842902/1K375
R37	1500 Ω	48 425 10/1K5	C34	100 pF	48 406 10/100E
R38	330 Ω	48 425 10/330E	C35	0,1 μF	48 751 10/100K
R40	47 Ω	48 425 10/47E	C36	10 pF	48 406 99/10E
			C37	2200 pF	48 751 10/2K2
			C38	100 pF	48 406 10/100E
			C39	400 pF	48 429 10/400E
			C40	22000 pF	48 751 10/22K
			C41	4000 pF	28 199 71.0
			C42	8200 pF	48 751 10/82K
			C43	0,1 μF	48 751 10/100K
			C44	0,1 μF	48 751 10/100K
			C45	2 pF	28 205 88.0
			C46	2,5-30 pF	28 211 83.1
			C47	22 pF	48 406 10/22E
			C49	250 pF	48 429 10/250E
			C55	47000 pF	48 752 10/47K
			C56	47000 pF	48 752 10/47K

S1, S2, S3, S4	28 529 61.1* 28 530 74.1* <sup>1)</sup> 28 546 08.1	S18, S19	28 587 09.0
S5	28 570 48.1*	S20, S21, C23	28 570 53.1
S6, C13	28 570 48.1*	S22, S23, S24, C25	28 570 72.0
S7, S8, S9, S10, C14	28 570 54.1	S25	28 546 21.2
S11, S12, C15	28 570 49.1*	S26, S27	28 530 54.0
S13	28 587 08.0	S28	28 220 29.1
S14, S15, S16 } S17, C18 }	28 570 50.1*	S30	28 587 47.0*
		S31	28 587 47.0*

## U

R1	100/2 Ω	48 427 10/100E	C1	0,1 μF	28 196 08.0*
R2	5000 Ω	28 802 48.0*	C2	0,1 μF	
R3	1000 Ω	28 801 78.0*	C3	0,1 μF	
R4	4000 Ω		C8	0,2 μF	
			S3	—	
			C4	0,5 μF	28 196 07.0*
			C5	0,25 μF	
S1 T		28 890 29.0*	C6	0,1 μF	
S2, S3, S4		28 571 11.0*	C7	0,1 μF	
S5, S6		28 882 34.0*	C9	2000 pF	
R5 100 Ω			C10	2000 pF	
Z1	1A	08 140 39.2			
Z2	1A	08 140 39.2			

93 952 18.1

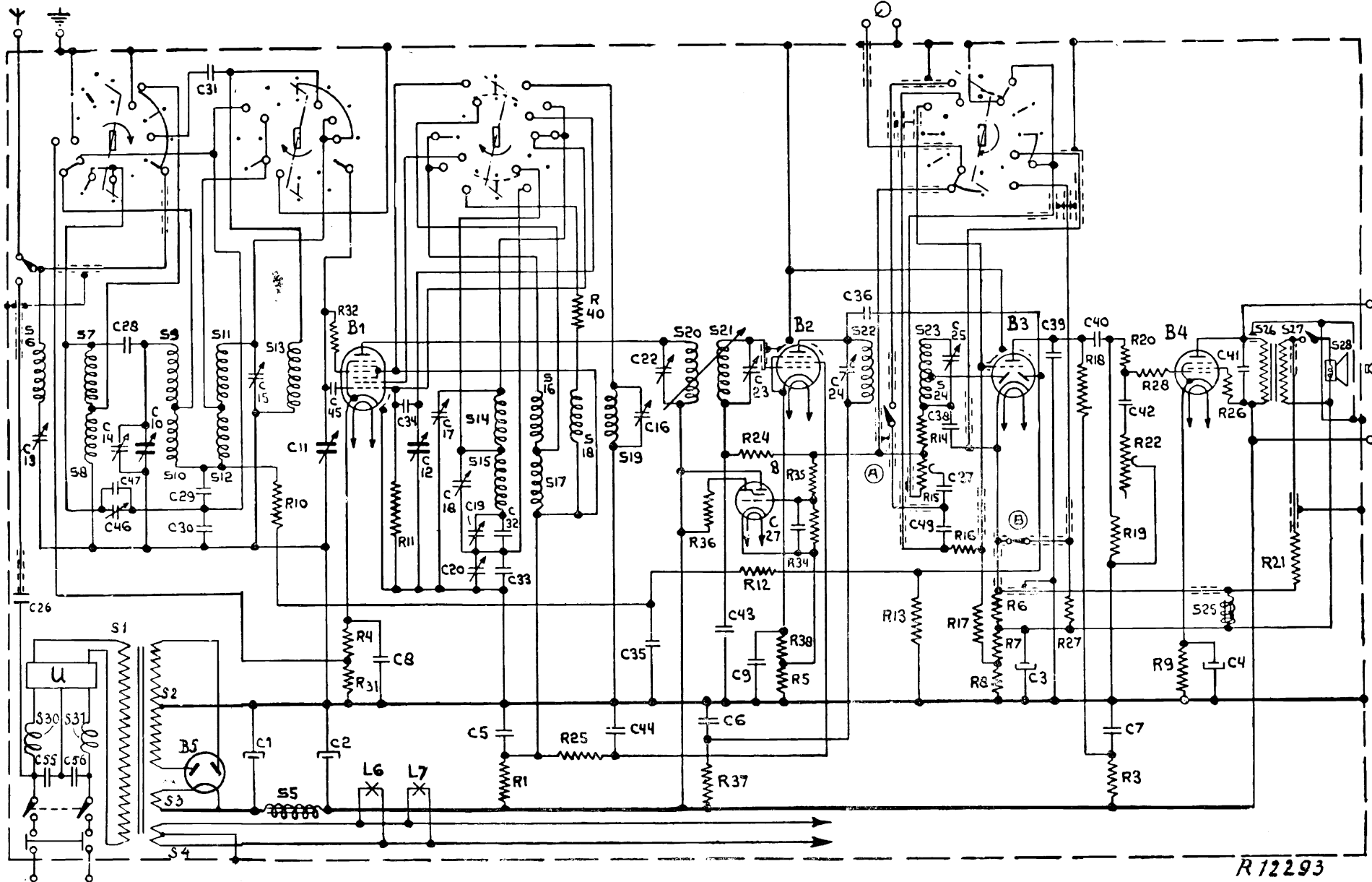

R12293

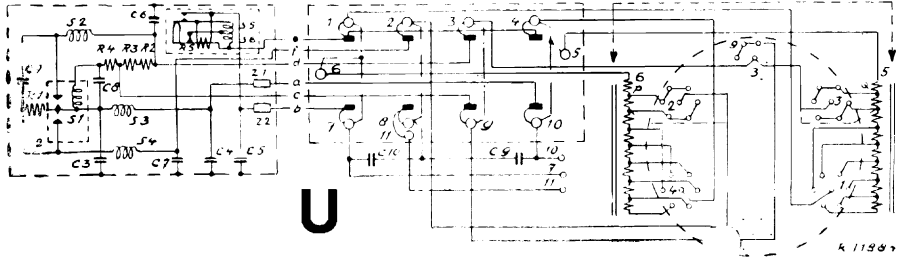

U

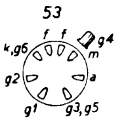
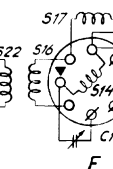
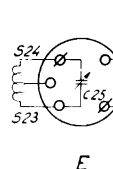
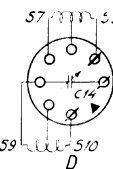
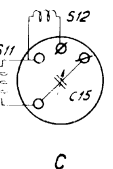
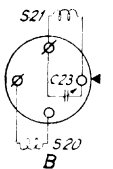
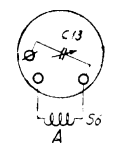

B 1  
AK 2

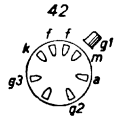

B 2  
AF 3

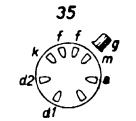

B 3  
ABC 1

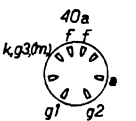

B 4  
AL 4

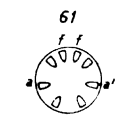

B 5  
AZ 1

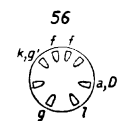

B 8  
AM 1

R104064