

PHILIPS-SERVICE

916 X -05, -08, -10, -11, -50

13.5—46 m
46—160 m
160—585 m
708—2000 m (-05, -50)
452 kc/s

9640-05 Z = 6 Ω
110, 125, 145, 200, 220, 240 V
47 W

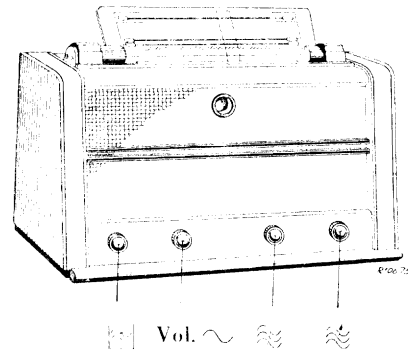

160—585 m	13.5—46 m	708—2000 m (-05, -50)
C3, C4, C5 min.	20.5 Mc/s —	C3, C4, C5 + 15°
452 kc/s-33000 pF-g1B2	C3, C4, C5 min.	400 kc/s —
S24—82 pF	C3, C4, C5 20.5 Mc/s	C63, C62, C61 max.
S25, S31—82 pF	C8, C15 max.	-25 pF — a B2
S23 max.	46—160 m	C5
S26, S27 max.	C3, C4 C5 + 15°	160 kc/s —
S24	6.1 Mc/s —	C3, C4, C5 160 kc/s
S25, S31	C25, C16, C9 max.	C5
S23—82 pF	160—585 m	C5
S26, S27—82 pF	C3, C4, C5 + 15°	C64 max.
S24 max.	1650 kc/s —	
S25, S31 max.	C26, C17, C10 max.	
S23	-25 pF — a B2	
S26, S27	C5	
	545 kc/s —	
	C3, C4, C5 545 kc/s	
	C5	
	C 30 max.	

15° = 09 992 44.0

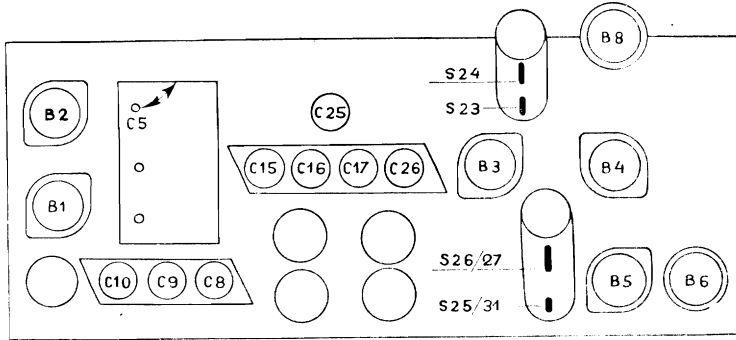

-08, -10, -11

R10330

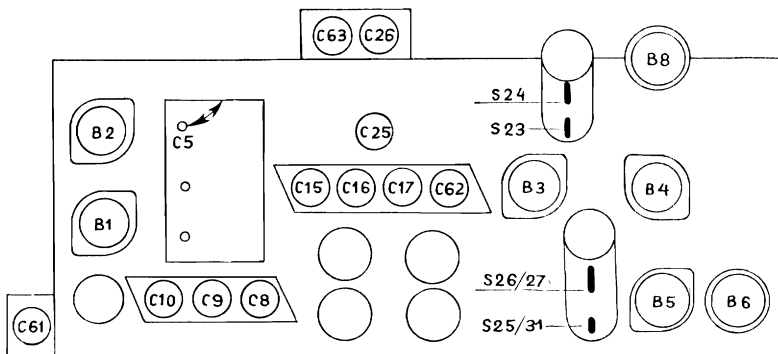

-05 -50

R10342

	B1	B2	B3	B4	B5	B6	B8
	EF 9	ECH 4	EBF 2	EF 9	EL3	AZ1	EM 4
Va	150	220 130	220	110	250		60 40
Vg2 (+4)	85	80	80	30	220		230
Vk	0.5	1.5	11	1.3	5		1.3
Ia	6	1.5 5	3.2	0.5	25		0.1 0.1
Ig2 (+4)	2	3.8	1	0.4	3		0.12

R1	1890 Ω	48 495 10 1K8	C1	45 pF	49 025 22.0
R2	0.82 MΩ	48 425 10 820K	C2	45 pF	49 029 01.0
R3	68 Ω	48 425 10 68E	C3	11-490 pF	
R4	10000 Ω	48 427 10 10K	C4	11-490 pF	49 000 09.0
R7	150 Ω	48 425 10 150E	C5	11-490 pF	
R8	47000 2 Ω	48 427 10 47K	C6	10000 pF	48 750 10 10K
R9	220 Ω	48 425 10 220E	C8	20 pF	49 005 05.2
R10	39000 Ω	48 425 10 39K	C9	20 pF	49 005 05.2
R11	2 10000 Ω	48 426 10 10K	C10	20 pF	49 005 05.2
R14	0.1 MΩ	48 426 10 100K	C11	100 pF	48 466 10 100E
R16	0.15 MΩ	48 425 10 150K	C14	10000 pF	48 751 20 10K
R17	0.275 MΩ	19 500 09.0	C15	20 pF	49 005 05.2
R17a	0.075 MΩ		C16	20 pF	49 005 05.2
R18	2.2 MΩ	48 427 10 2M2	C17	20 pF	49 005 05.2
R19	4.7 MΩ	48 427 10 4M7	C19	10000 pF	48 750 10 10K
R20	1.5 MΩ	48 426 10 1M5	C20	56000 pF	48 751 10 56K
R21	0.1 MΩ	48 427 10 100K	C21	68 pF	48 466 10 68E
R22	1000 Ω	48 425 10 1K	C22	100 pF	48 466 10 100E
R23	0.5 MΩ	49 470 30.0	C23	220 pF	48 406 10 220E
R24	180 Ω	48 426 10 180E	C24		49 005 18.0
R27	56000 Ω	48 425 10 56K	C25	20 pF	49 005 05.2
R28	560 Ω	48 425 10 560E	C26	20 pF	49 005 05.2
R29	15000 Ω	48 425 10 15K	C27	6400 pF	48 429 02 6K4
R31	0.82 MΩ	48 426 10 820K	C28	1600 pF	48 429 02 1K6
R32	1 MΩ	48 426 10 1M	C29	400 pF	48 429 02 400E
R33	1000 Ω	48 425 10 1K	C30	125 pF	28 212 07.0
R35	0.1 MΩ	48 425 10 100K	C31	94 pF	
R37	2.2 MΩ	48 427 10 2M2	C32	100 pF	
R38	1.5 MΩ	48 426 10 1M5	C33	47000 pF	48 750 20 47K
R40	1.5 MΩ	48 426 10 1M5	C35	56000 pF	48 751 10 56K
R43	5600 Ω	48 427 10 5K6	C37	103 pF	
R44	2.2 MΩ	48 427 10 2M2	C38	113 pF	
R45	0.39 MΩ	48 425 10 390K	C39	100 pF	48 406 10 100E
R46	2200 Ω	48 425 10 2K2	C40	32 pF	49 020 41.0
R47			C41	22000 pF	48 750 10 22K
	(-05,-50) 12000 Ω	48 425 10 12K	C43	22000 pF	48 751 20 22K
	(-08, -10, -11)		C44	2200 pF	48 757 20 2K2
	18000 Ω	48 425 10 18K	C46	22000 pF	48 750 10 22K
R48	47000 Ω	48 426 10 47K	C47	0.1 pF	48 751 20 100K
			C48	0.33 pF	48 750 10 330K
			C49	56 pF	48 406 10 56E
			C50	14 pF	C 2
			C51	64 pF	49 020 40.0
			C52	630 pF	48 751 20 680E
			C54	10000 pF	48 750 10 10K
			C56	5.6 pF	48 406 99 5E6
			C57	47000 pF	48 750 10 47K
			C58	22 pF	48 406 10 22E
			C61		
			(-95,-50) 20 pF		49 005 05.2
			C62		
			(-05,-50) 20 pF		49 005 05.2
			C63		
			(-05,-50) 20 pF		49 005 05.2
			C64		
			(-05,-50) 200 pF		28 212 08.1
			C65	56 pF	48 406 10 56E
			C66	1.5 pF	49 055 60.0
			C67	82 pF	48 406 10 82E
			C68		
			(-05,-50) 330 pF		48 406 10 330E
			C69		
			(-95,-50) 39 pF		48 406 10 39E
			C70	47000 pF	48 750 20 47K
			C71	22000 pF	48 756 20 22K
			C72	32 pF	49 020 41.0
S1, S2, S3, S4, Z1	A1 956 48.0	S23, S24, S32, S35, C31, C32			A1 036 08.3
S5, S6, S7, S8	A1 035 61.1	S25, S26, S27, S31, C37, C38			A1 036 09.2
S9, S10, S40, S41	A1 036 62.0	S28, S29, S30, S34			A9 005 58.0
S12, S13, S14	A1 035 62.2	S33			49 981 06.0
S15, S16, S42, S43	A1 036 63.0				
S17, S18, S19, S20	A1 035 63.5				
S21, S22, S44, S45	A1 036 64.0				

916 X -05, -08, -10, -11, -50

S	1,2,3,4	40,5,6,7,8,9,10,41	42,43,12,13,14,15,16	44,45,17,18,19,20,21,22,35,32,23,24	25,26,27,31	28,29,30,33,34
C	6	71,1,8,9,10,61,2,3,57,11,65,14,54	23,66,67,68,62,15,16,17	4,20	19,21,22	5,64,69,50,24,25,26,27,28,29,30,36,63,31,32,33,35,58,70,37,38,72
R		2,3,4	48	8	7,9,10,11	32,40,38,44,14,37,45,46,17,16,18,19,20,31,33,35,27,28
						43,21,22,23,24
						47,29

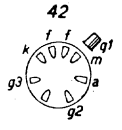

B1+B4

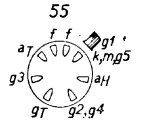

B2

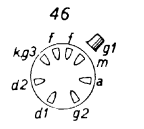

B3

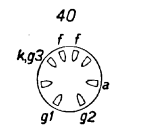

B5

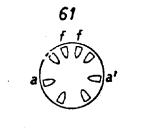

B6

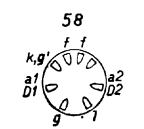

B8

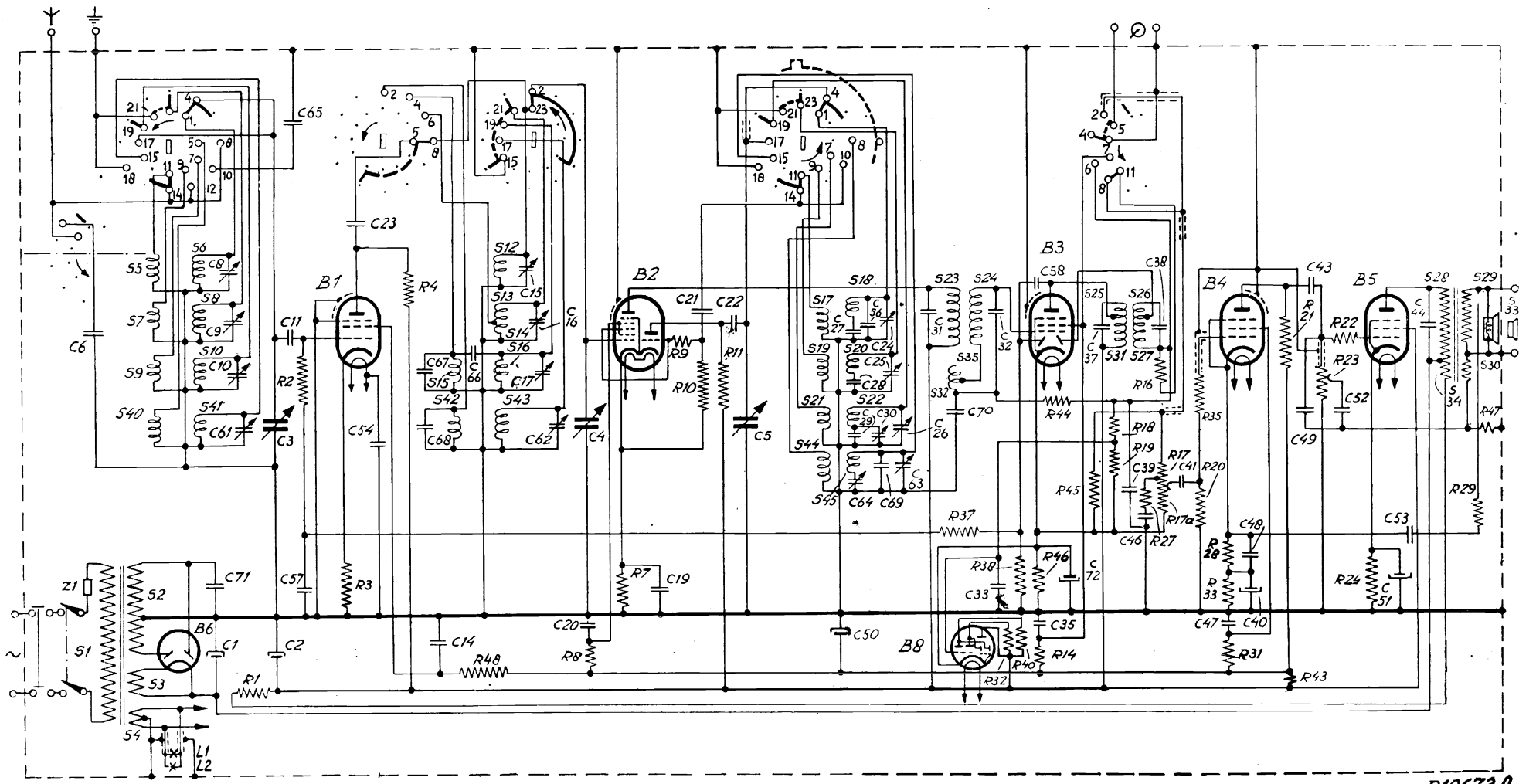

R10672A

